

Ecophon Solo[™] Circle

Ø800
M370

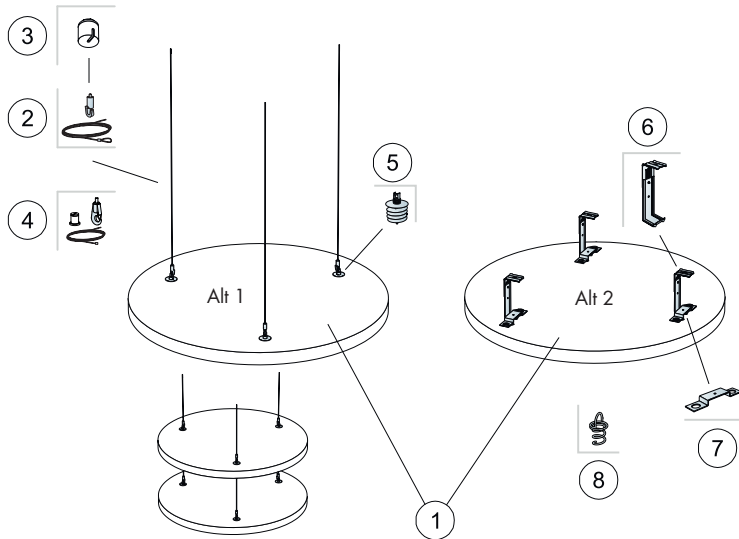

1. Ecophon Solo Circle Ø800

2. Connect Adjustable wire hanger
L=2000/5000 mm

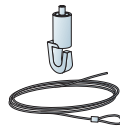

6. Connect Adjust bracket

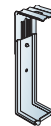

3. Connect Covering cup



7. Connect Panel Fixing plate



4. Connect Adjustable wire hanger kit
L=800/1500 mm



8. Connect Spiral anchor flat



5. Connect Absorber anchor



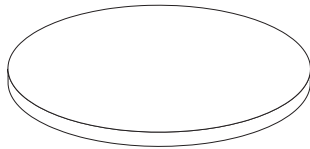
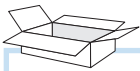

x4

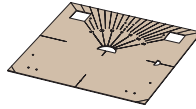

x1



Connect Anchor screw with eye

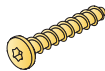

Connect Anchor screw

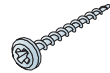

Connect Installation screw MWL

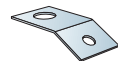

Connect Fixing plate C3

Ecophon[®]
SAINT-GOBAIN

A SOUND EFFECT ON PEOPLE

www.ecophon.com

Alt 1

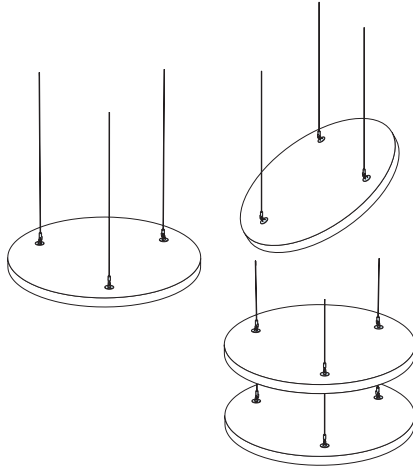

→ 1

Alt 2

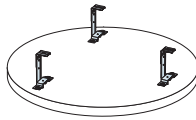

→ 10

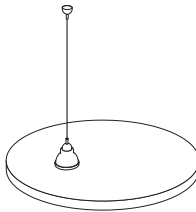

→ 15

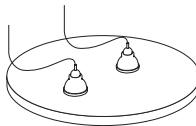

→ 18

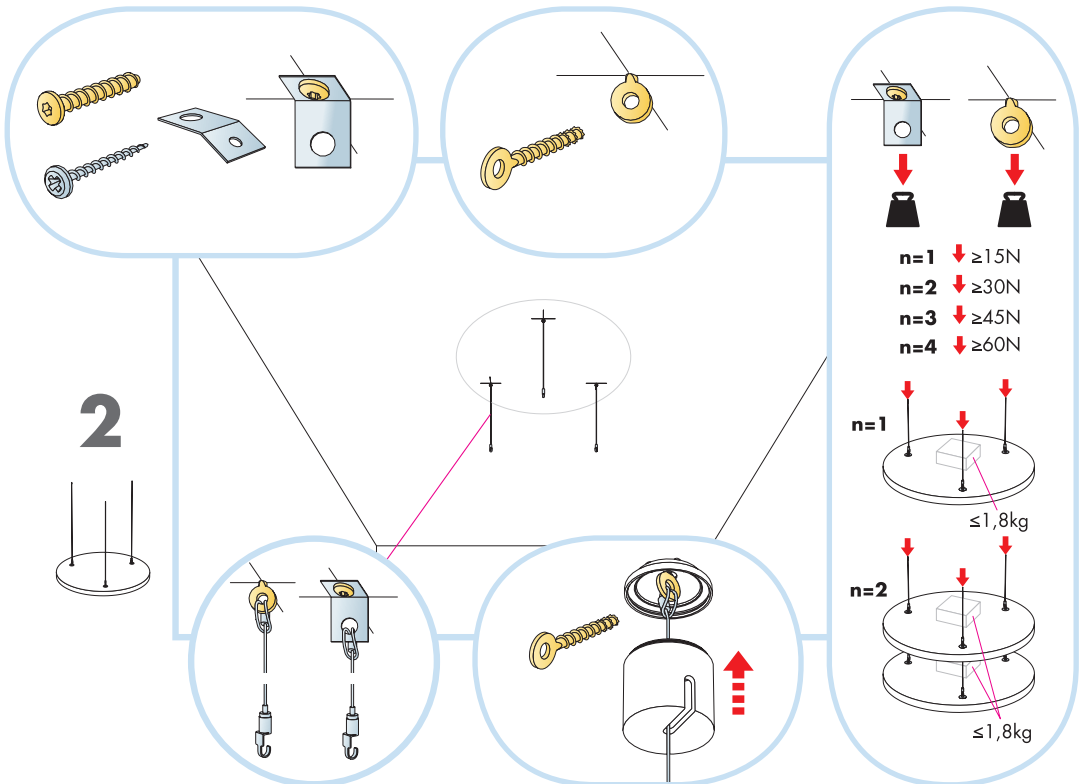
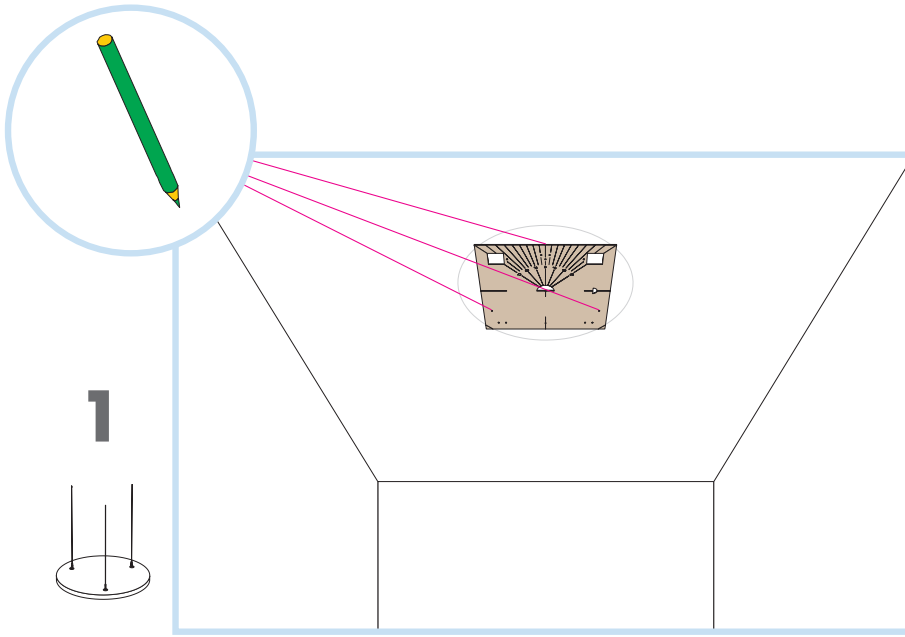

3

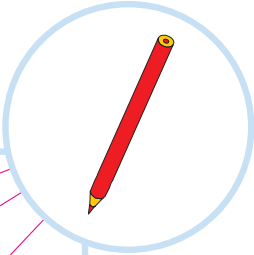
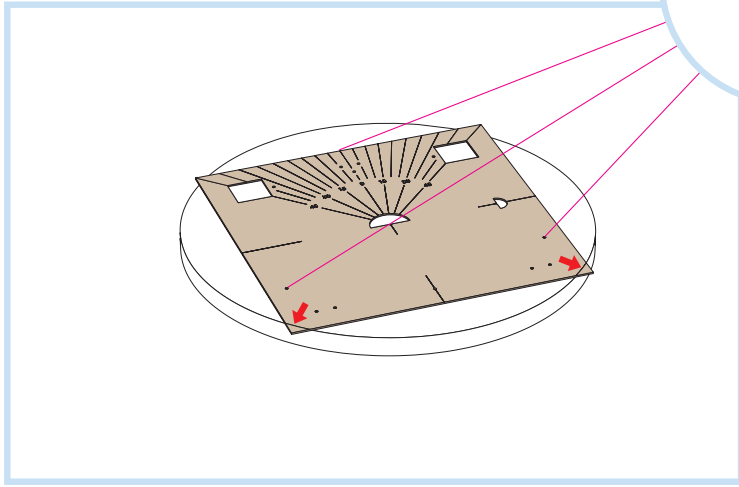
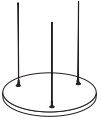

4

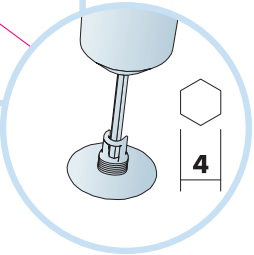
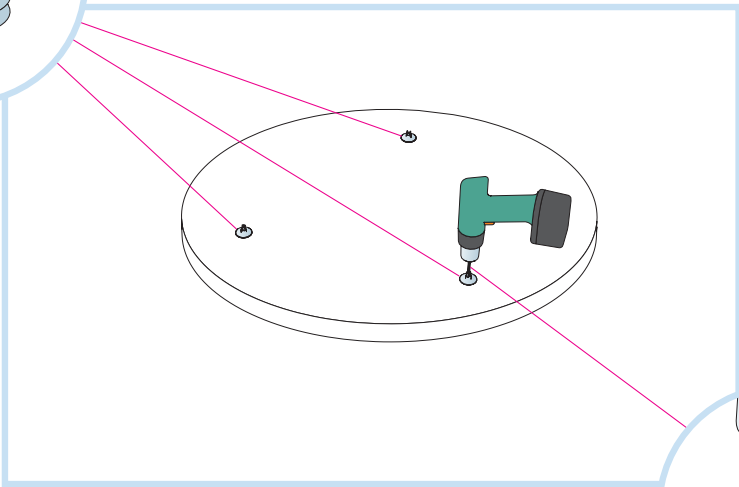

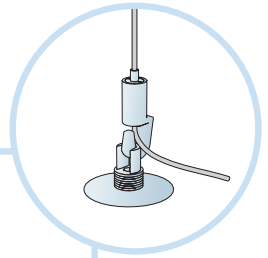
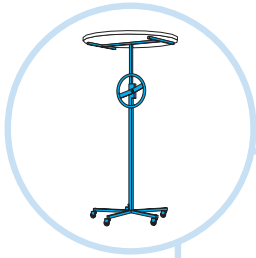

5

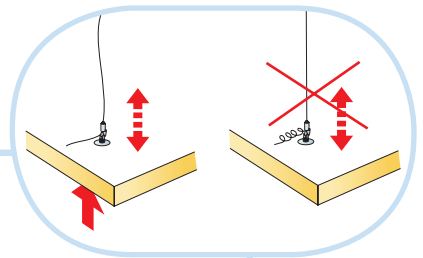
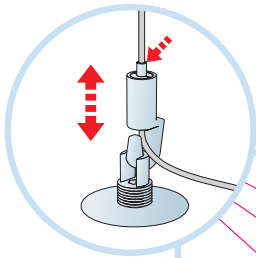
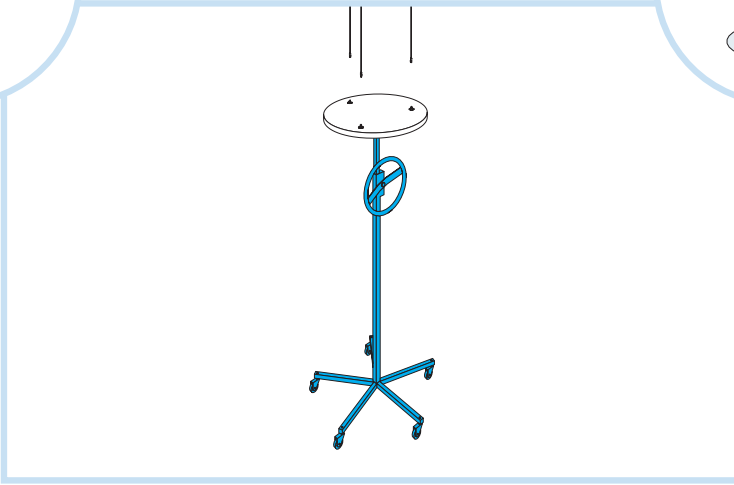

6

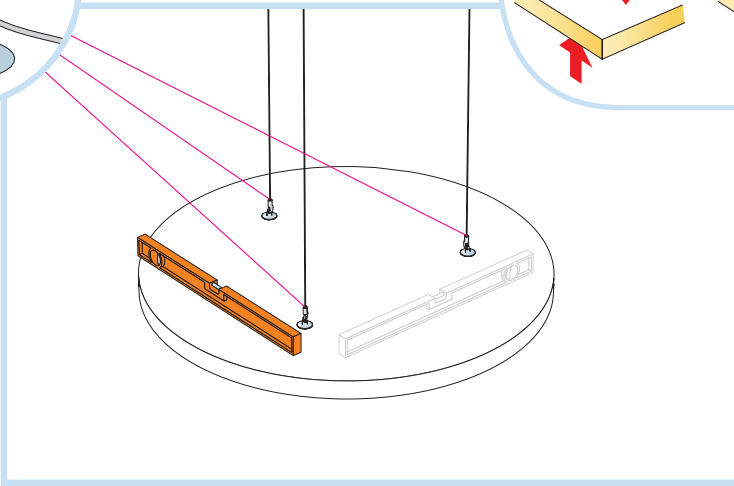
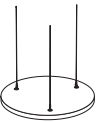

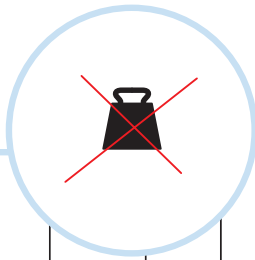
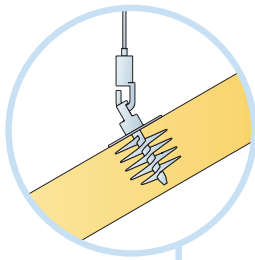

α	L
15°	435
30°	390
45°	320
60°	225

7

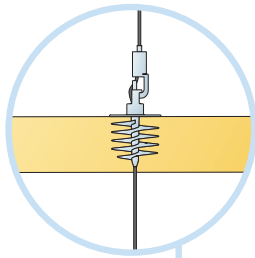
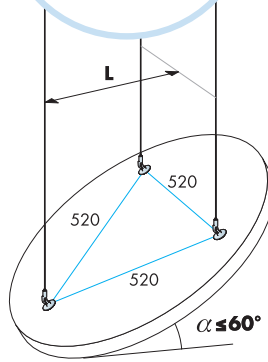

8

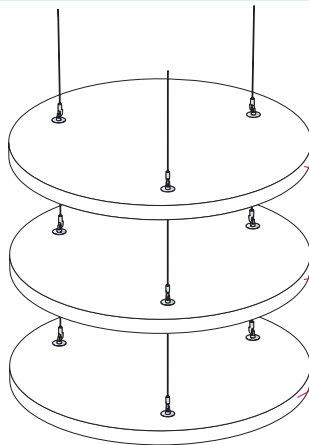
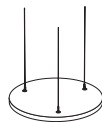

≤4

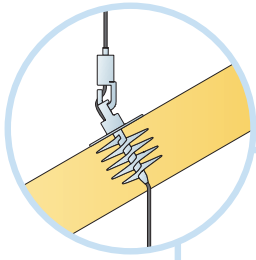

9

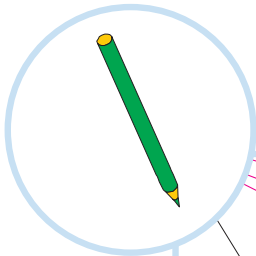
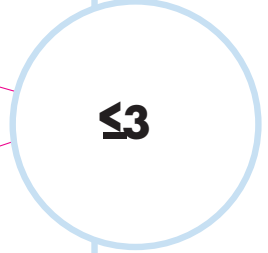
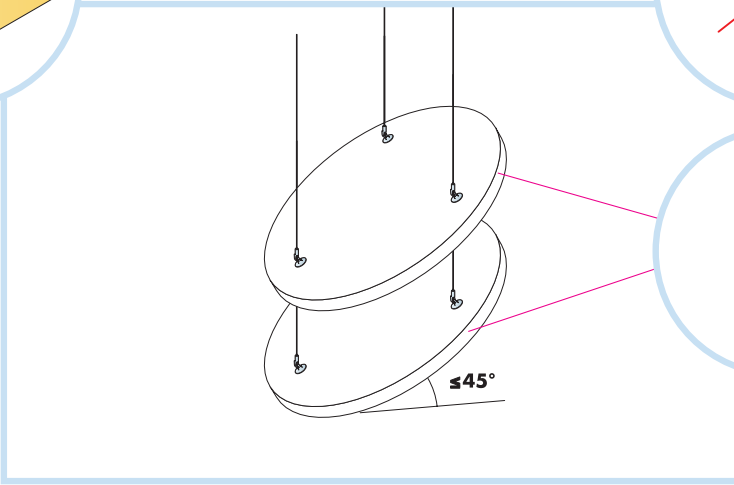

10

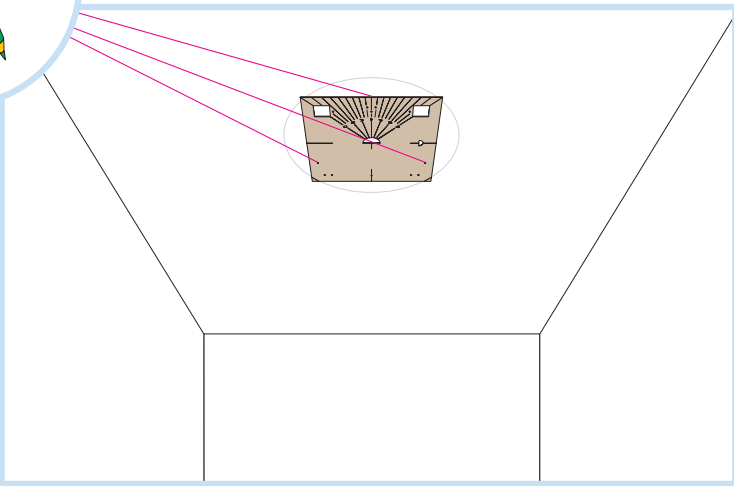

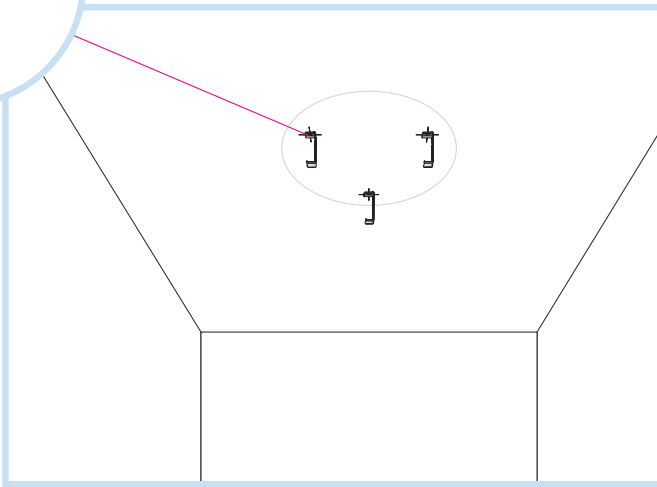
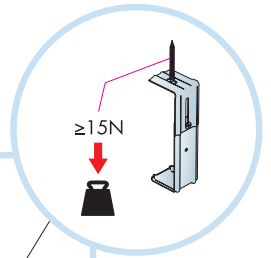
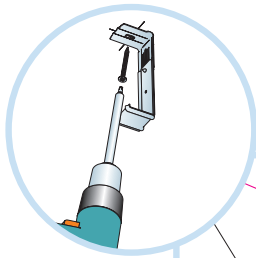

11

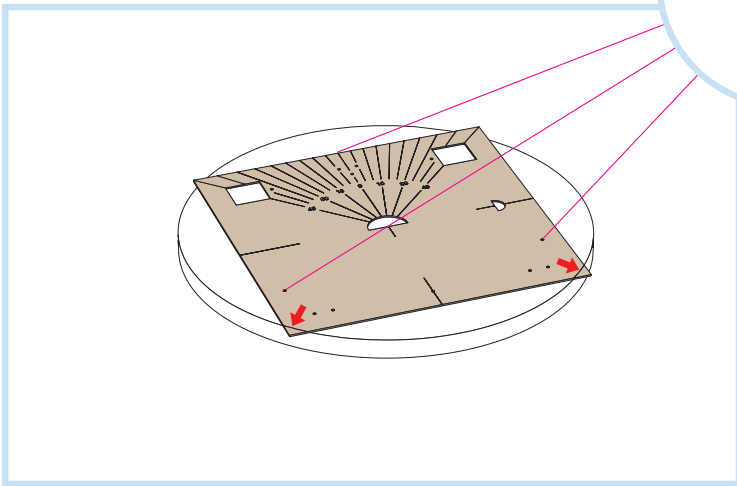
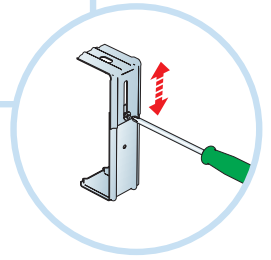
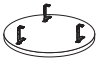

12

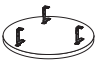

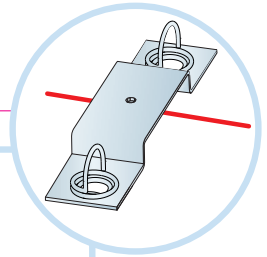
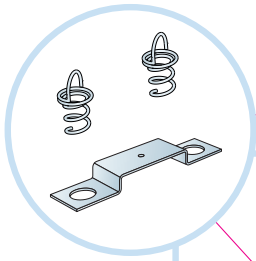

13

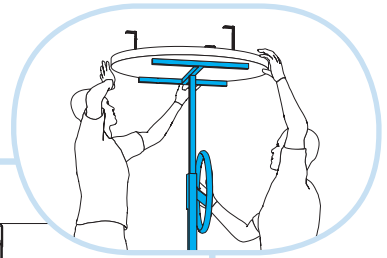
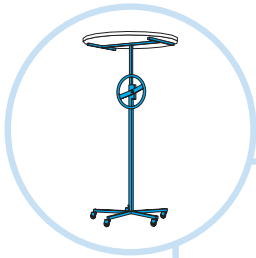
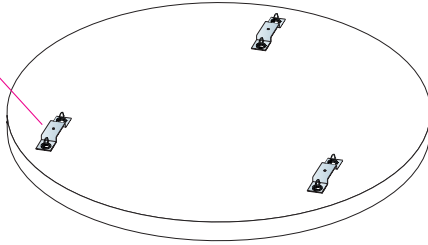

14

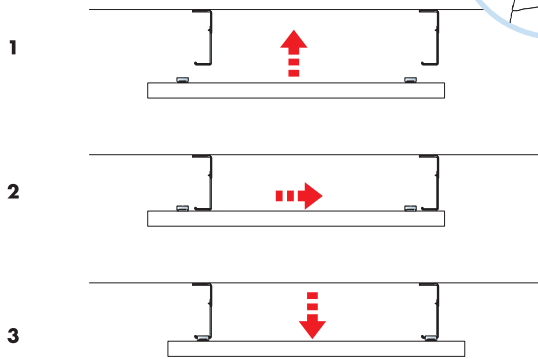
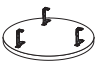

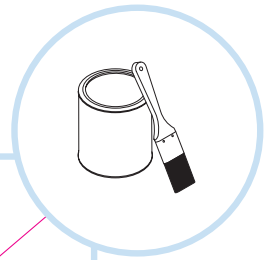
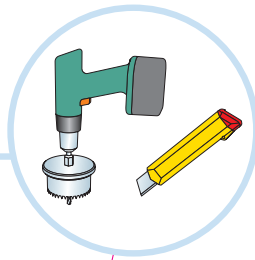
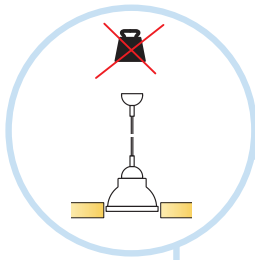

15

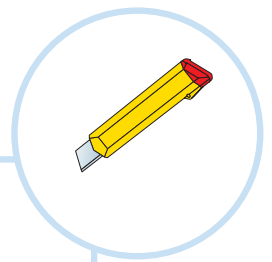
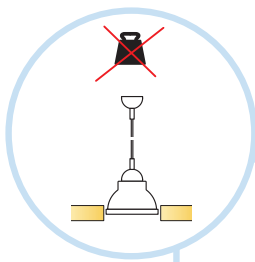
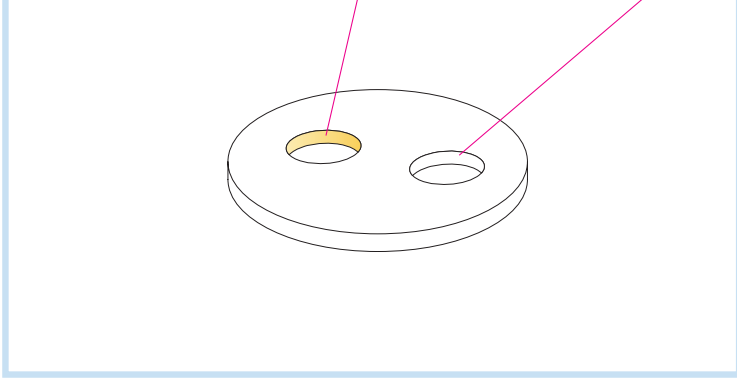

16

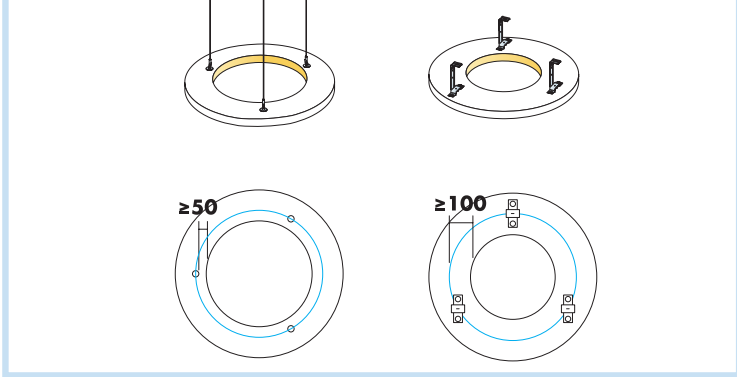

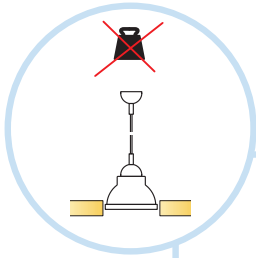

17

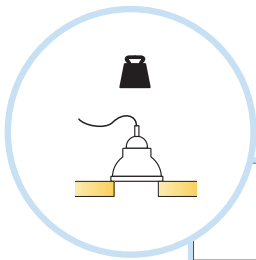
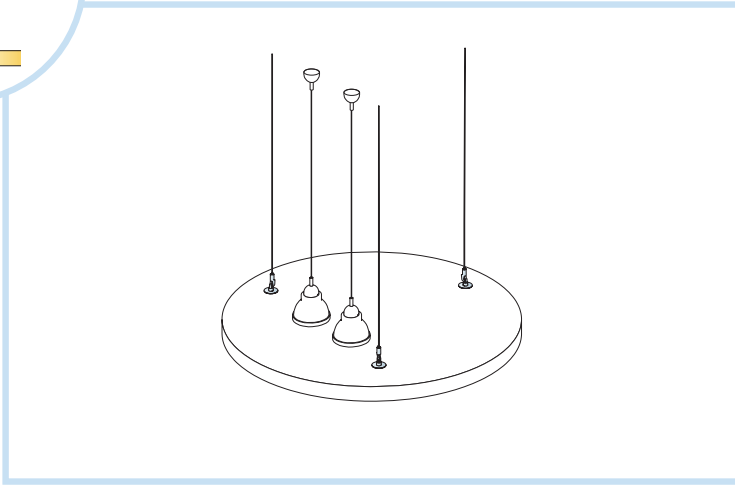

18

	$\leq 100\text{mm}$	$101-300\text{mm}$	$301-400\text{mm}$
	$\geq 150\text{mm}$	$\geq 150\text{mm}$	-
	$\leq 0,5\text{kg}$	$\leq 1,5\text{kg}$	$\leq 1,5\text{kg}$
	$\leq 1,8\text{kg}$	$\leq 1,8\text{kg}$	$\leq 1,5\text{kg}$

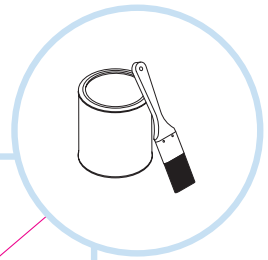
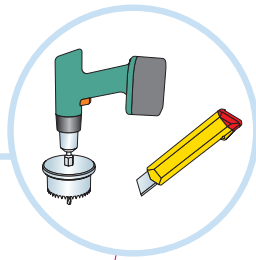
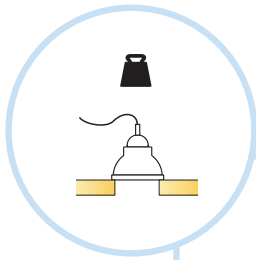

19

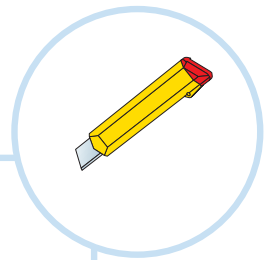
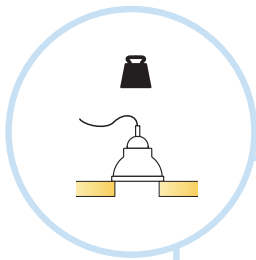
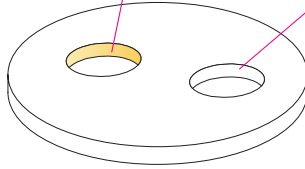

20

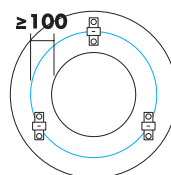
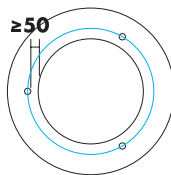
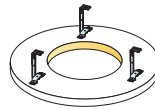

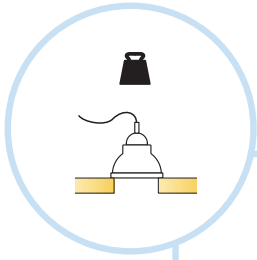

21

