

Ecophon Akusto Wall C with Thinline

Vertical installation 2700x600

M356

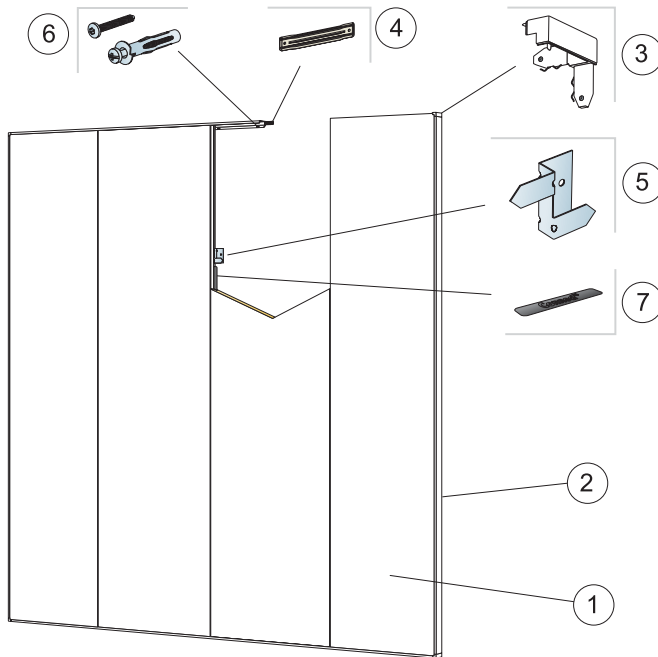

1. Ecophon Akusto Wall C.

2. Connect Thinline profile.

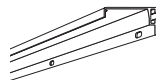

3. Connect Thinline corner.



4. Connect Thinline splice.



5. Connect Ambit fixing.



6. Installation screw, installed at 200 mm centres



7. Connect Spline



Ecophon[®]
SAINT-GOBAIN

A SOUND EFFECT ON PEOPLE

www.ecophon.com

1

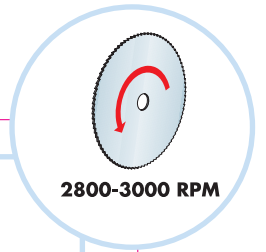
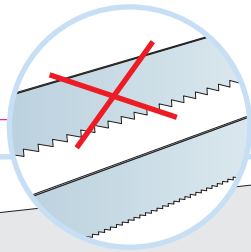
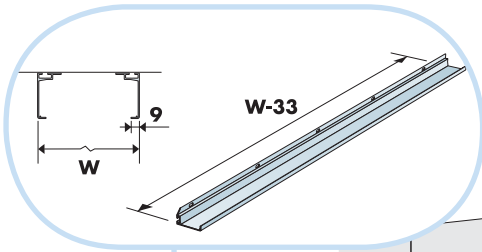
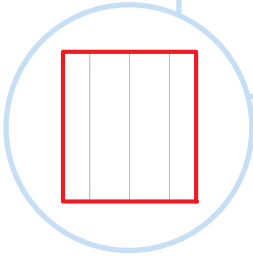
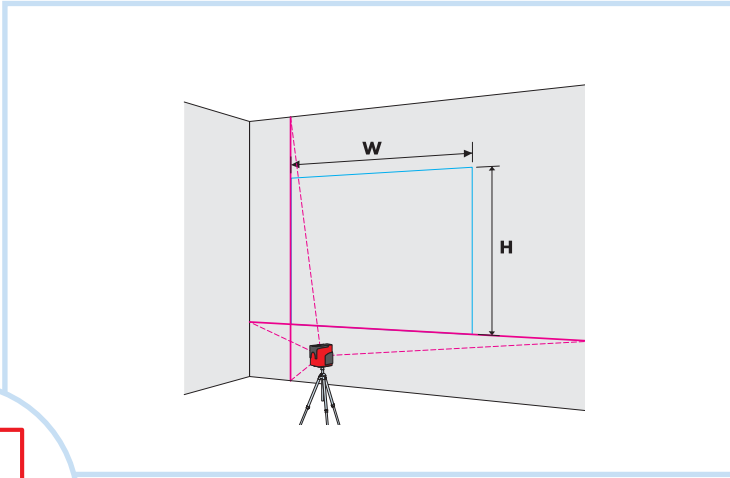

2

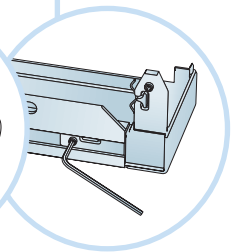
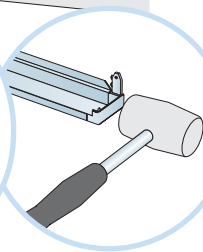
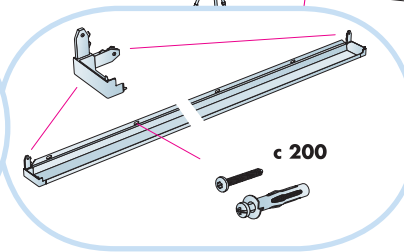
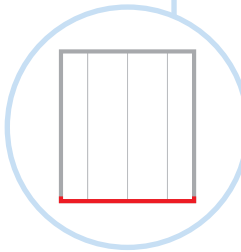
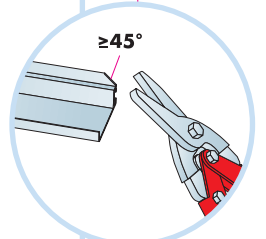
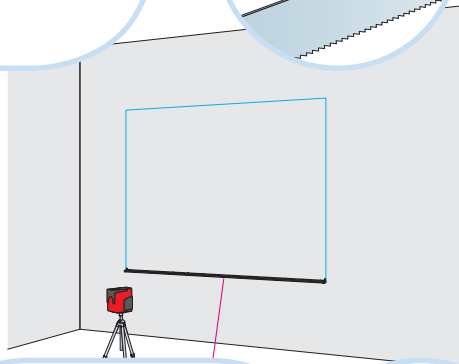

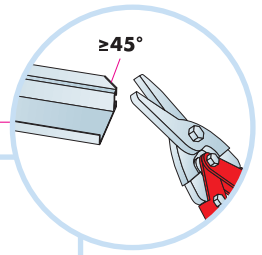
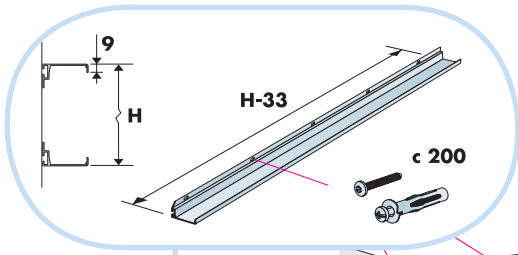

3

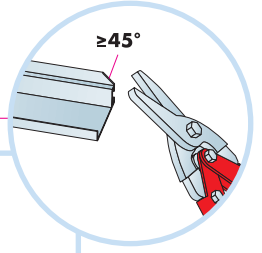
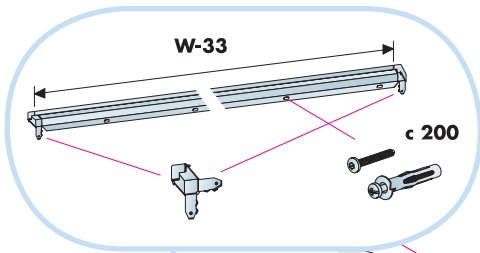
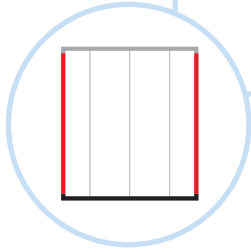
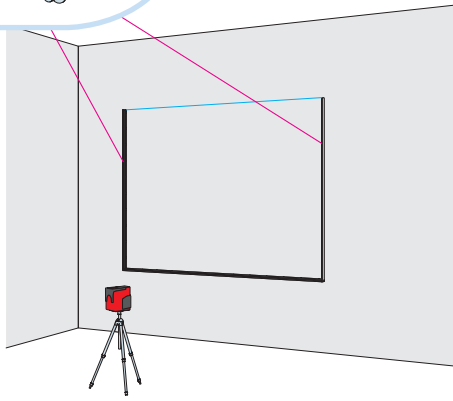

4

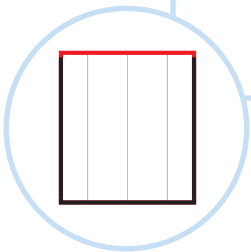
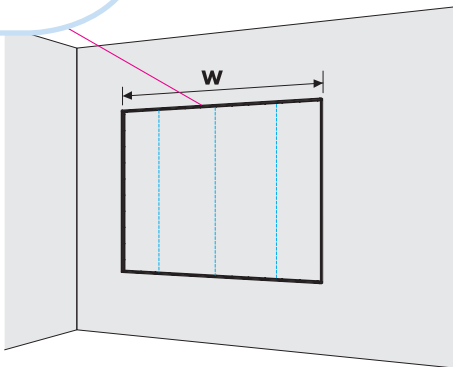

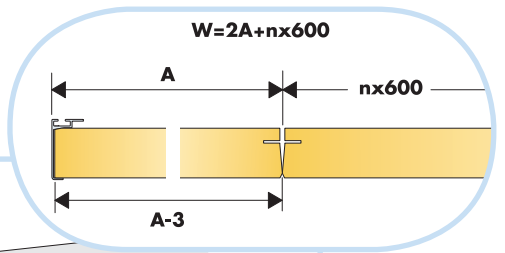
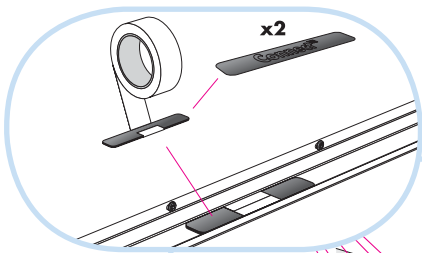

5

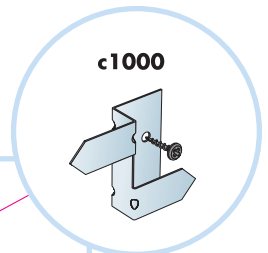
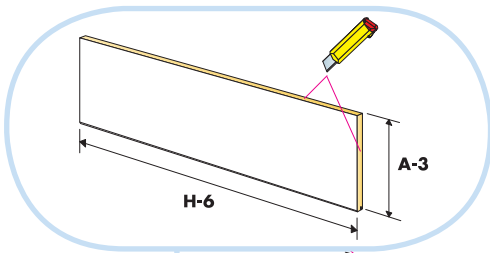
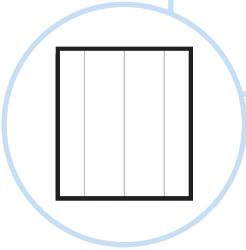
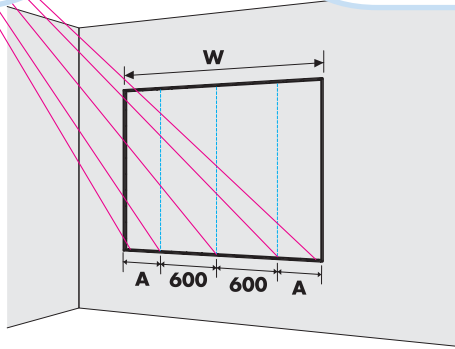

6

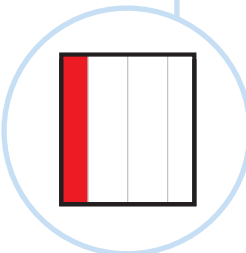
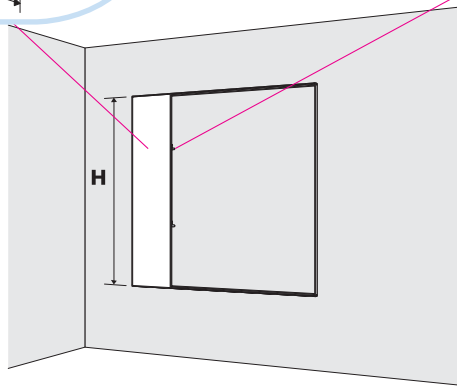

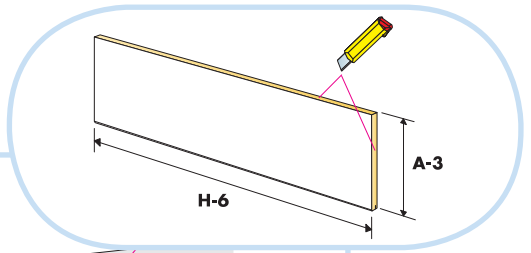
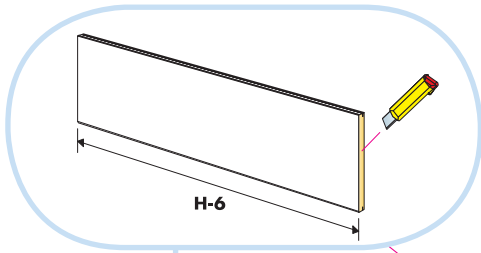

7

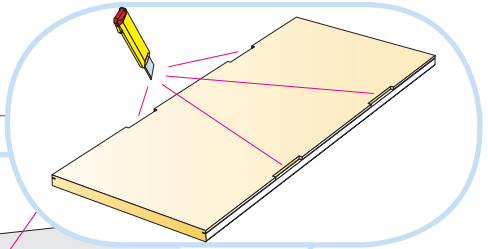
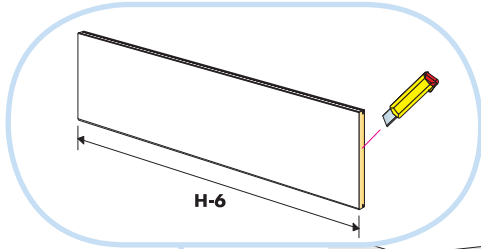
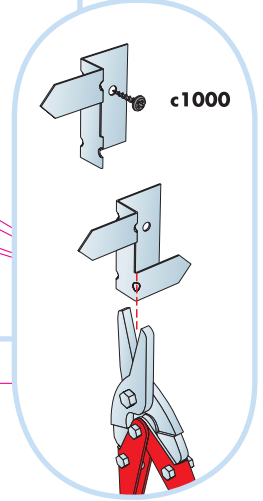
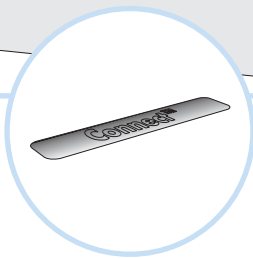
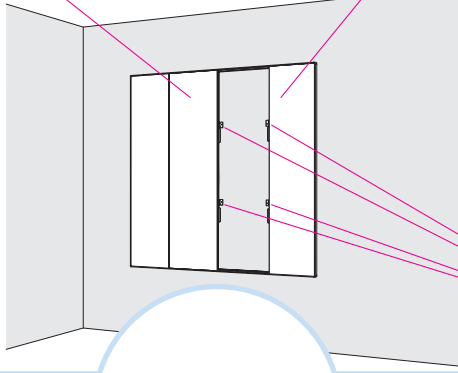

8

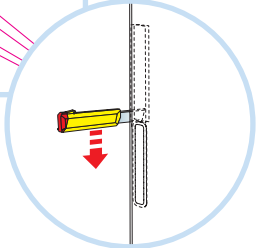
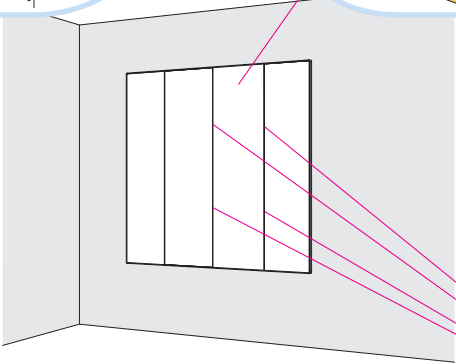
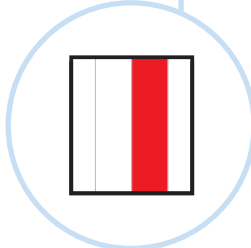

H/W > 2700

9

