

Ecophon Master F

600x600, 1200x600

M52

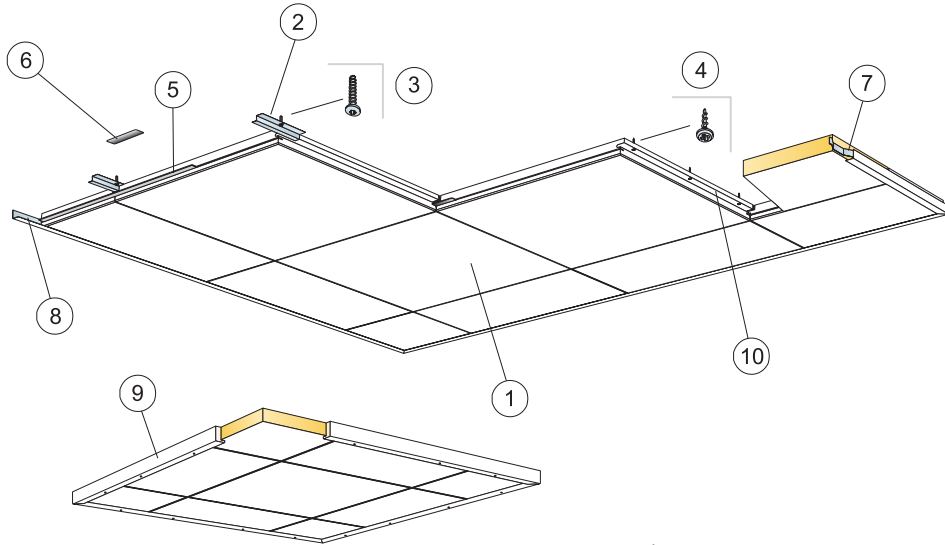

1. Ecophon Master F

2. Connect Direct fixing plate F, installed at 600 mm centres (for use in concrete)

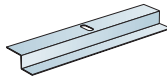

3. Connect Anchor screw, installed at 600 mm centres (for use in concrete)

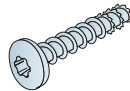

4. Connect Installation screw MVL, installed at 200 mm centres (for use in plasterboard or timber)



5. Connect Spline F, L=600 mm. Must be used in Sweden, Denmark, Norway and Finland at fireclass "Tändskyddande beklädnad"

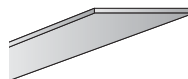

6. Connect Spline, L=150 mm



7. Connect Wall spring spacer



8. Connect Angle trim, fixed at 300 mm centres

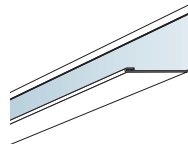

9. Timber installed at 600 mm centres (300 mm if thermal insulation is placed above), with the screw fixings along the timber.

10. For use when installing floating ceilings: Connect Wood trim, L=3000 mm, fixed at 500 mm centres

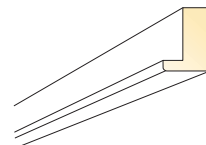

1

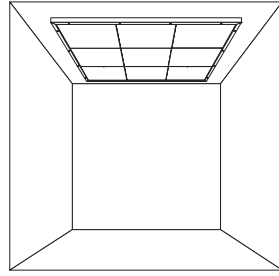
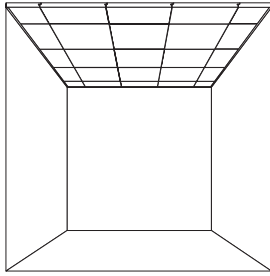

2



19

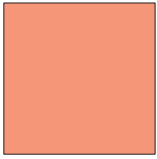

2

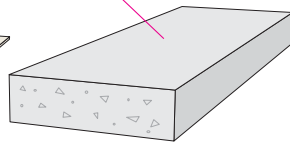
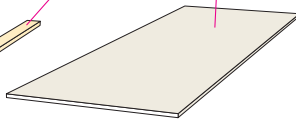
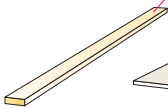
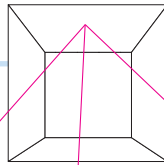

3



4



4

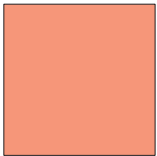

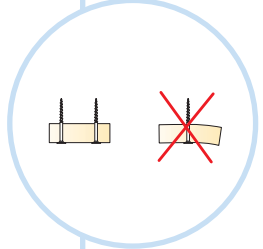
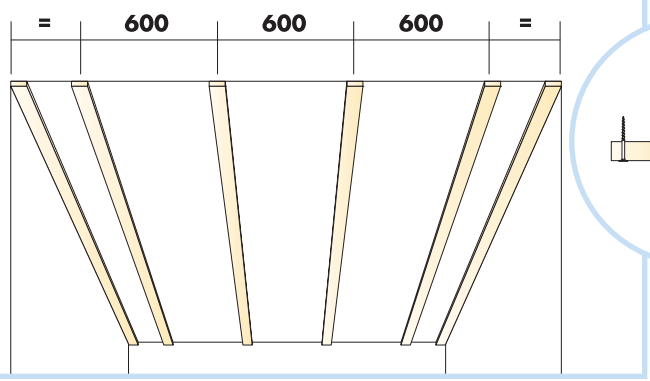
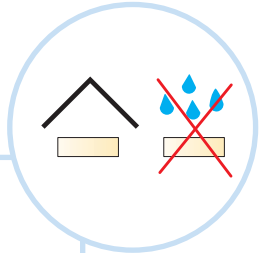
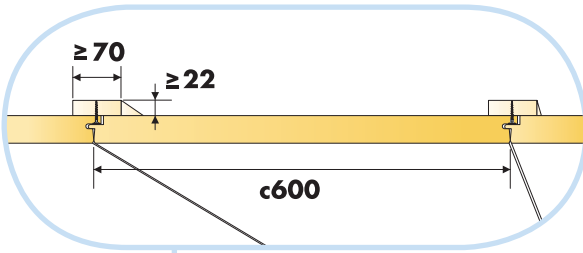

3

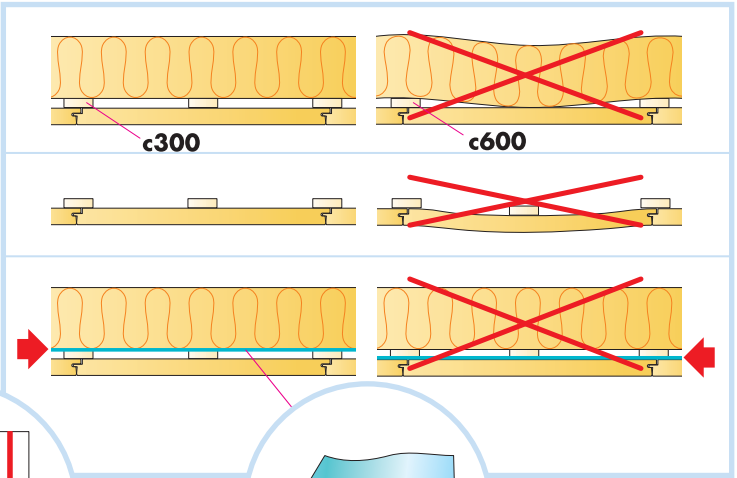
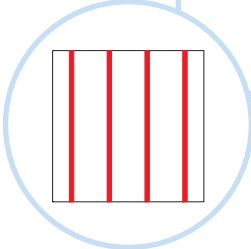

3'

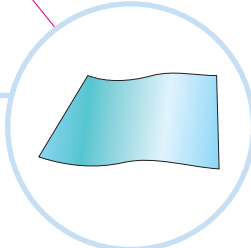
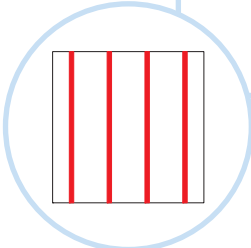

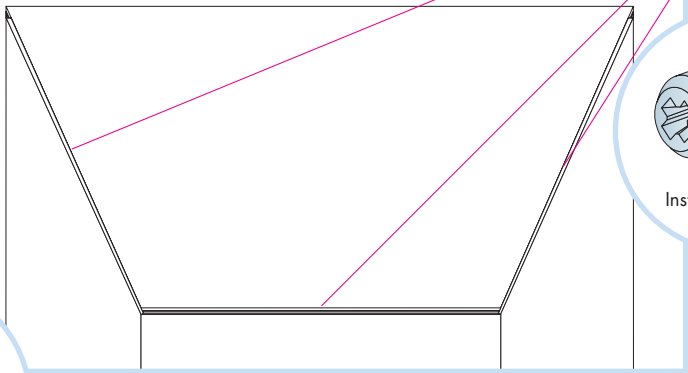
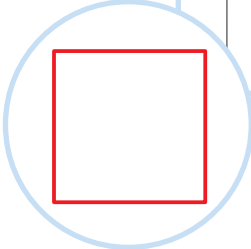
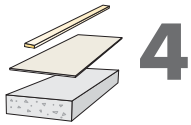
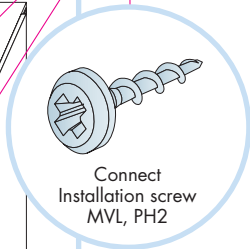
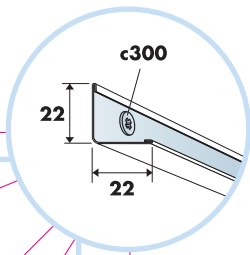
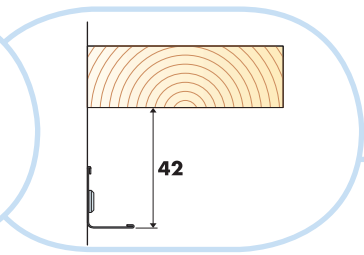
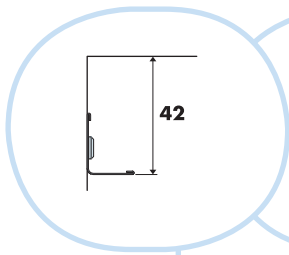

600x600

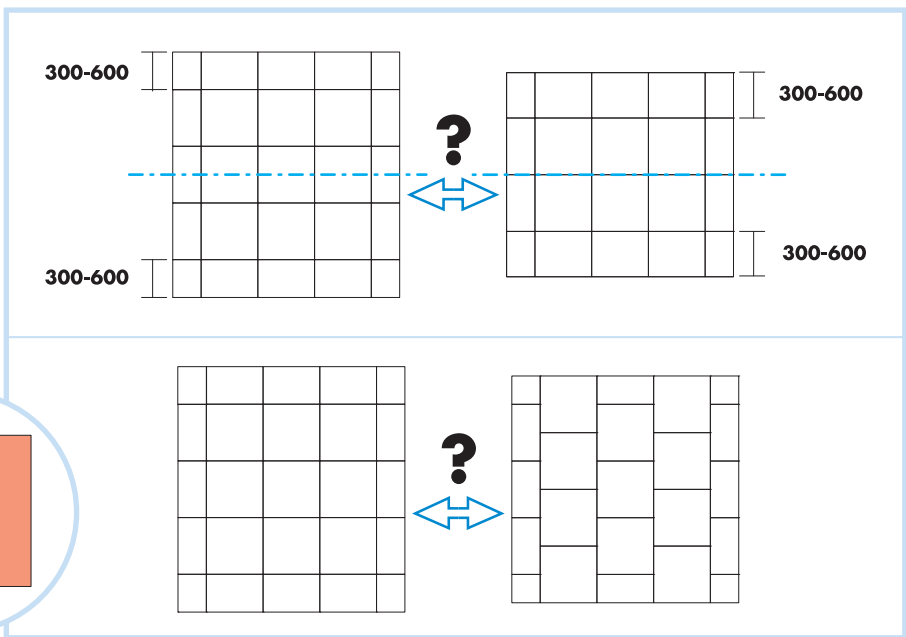
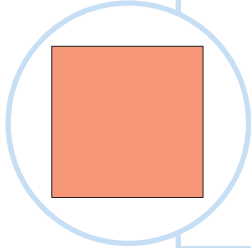
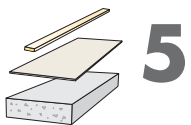

1200x600

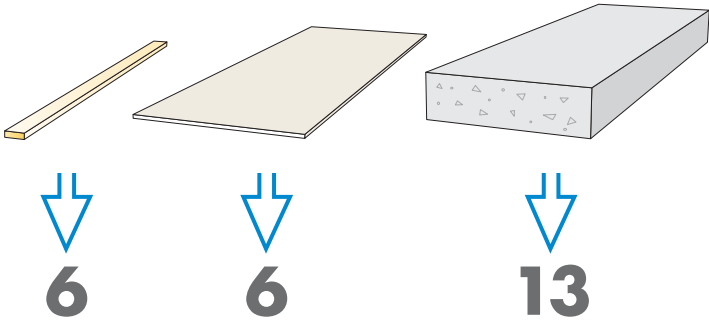
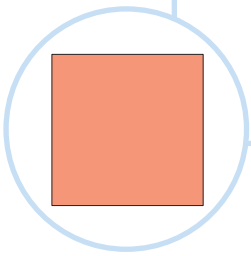
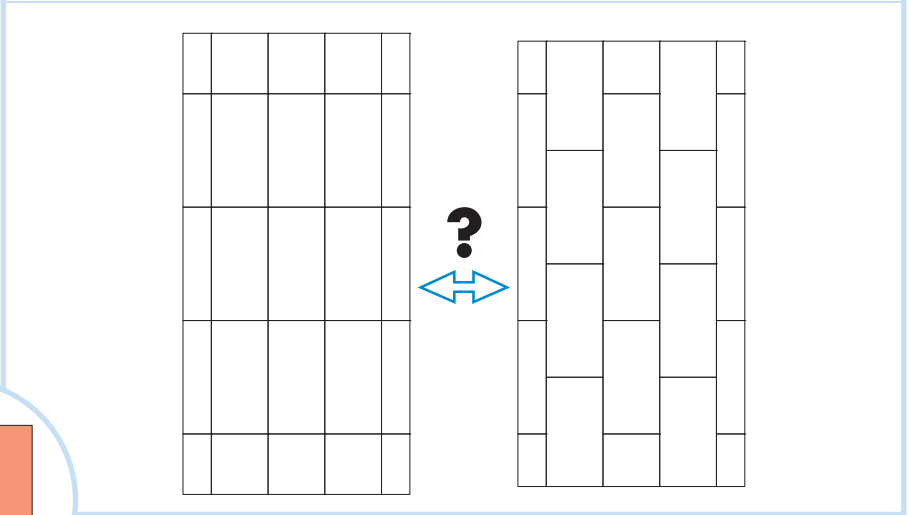
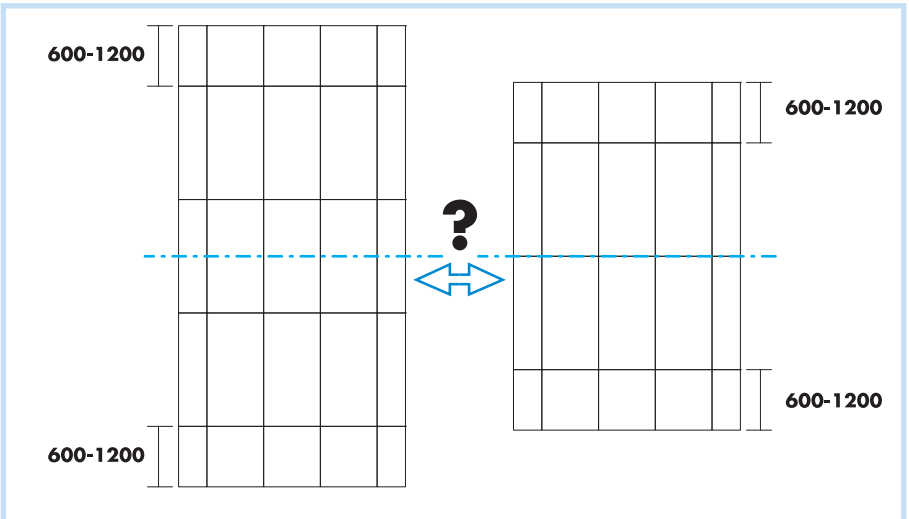

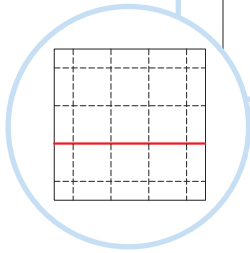
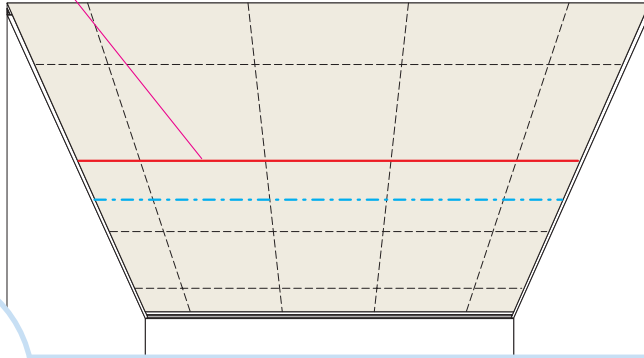
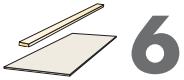
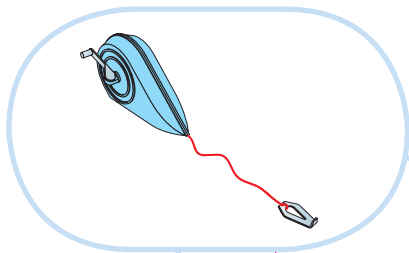

B=600

B=1200

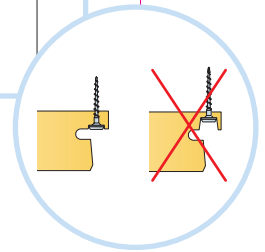
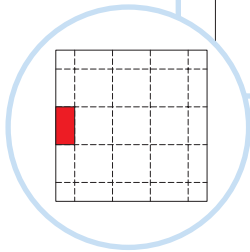
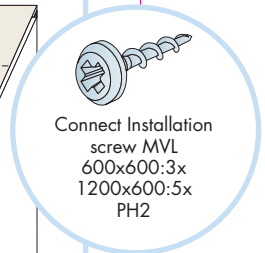
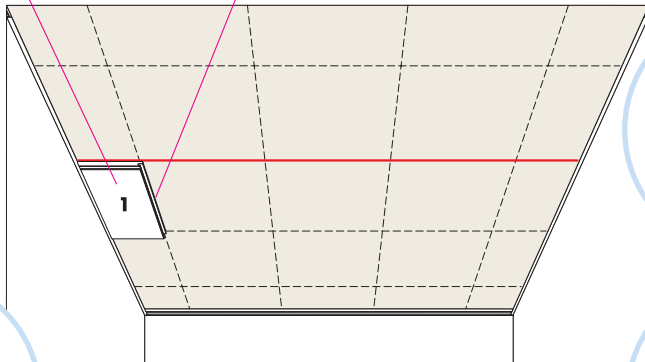
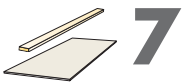
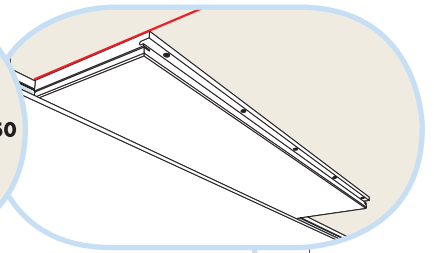
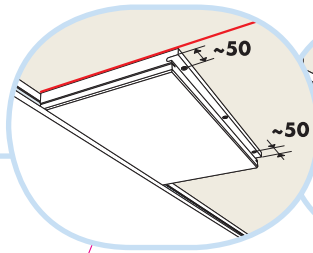
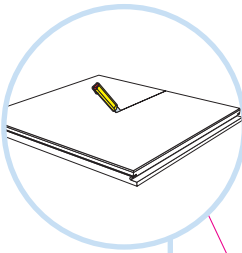

Connect Spline

Connect Spline F

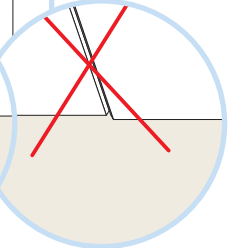
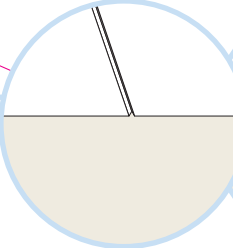
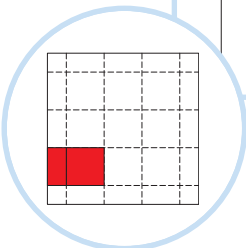
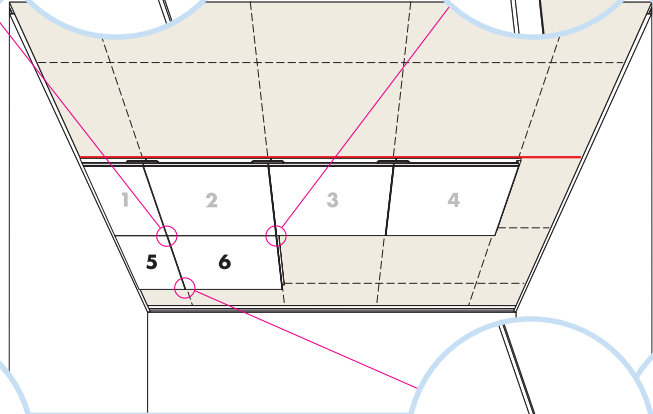
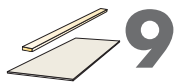
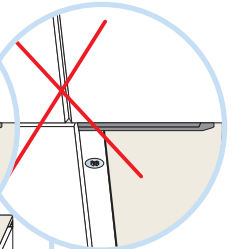
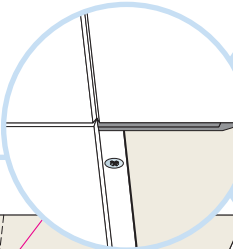
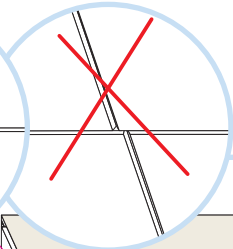
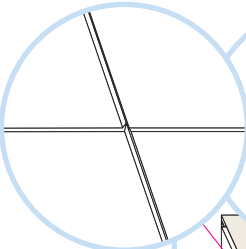
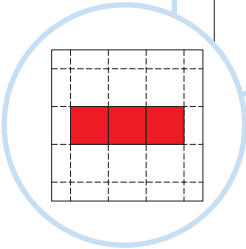
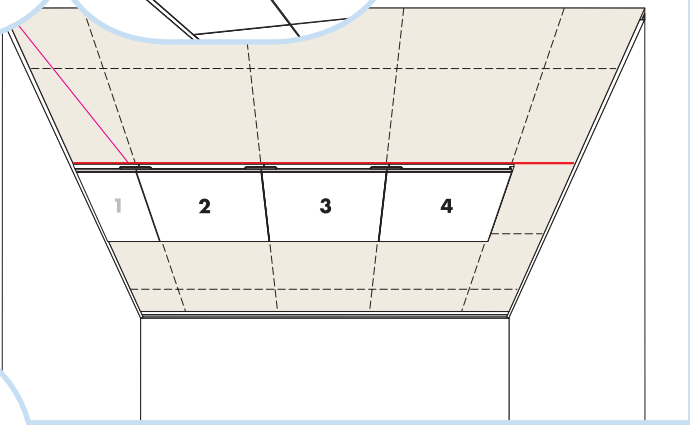
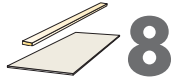

 **10**

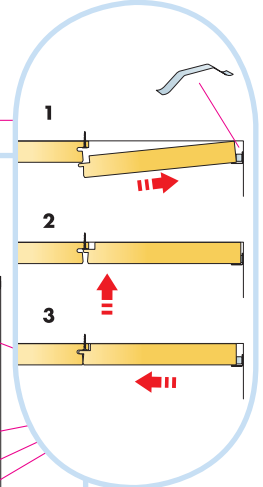
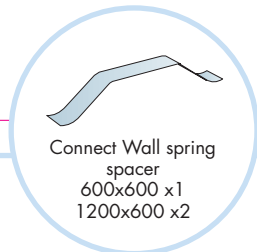
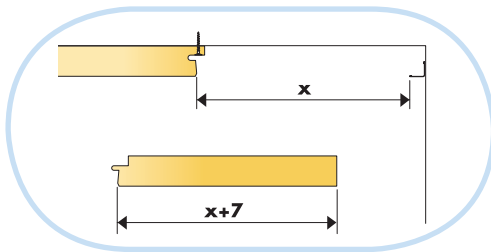
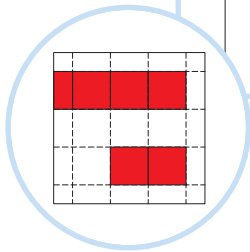
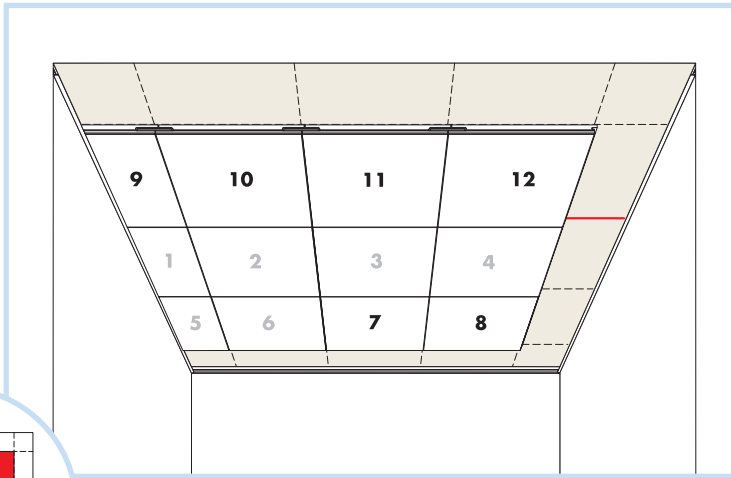

 **11**

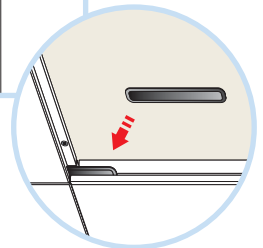
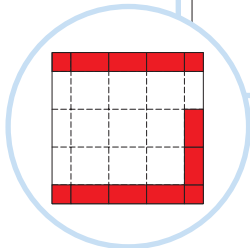
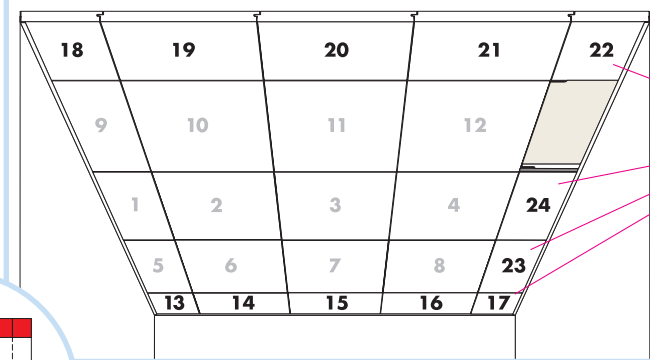

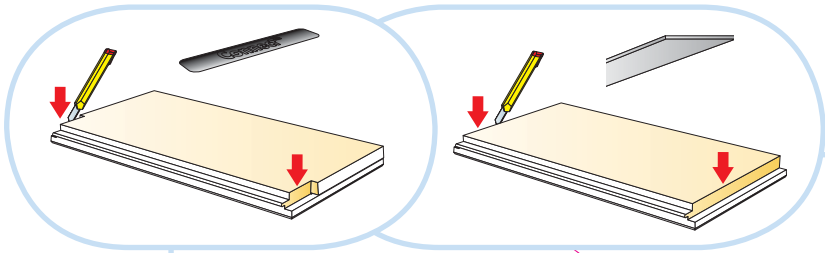

12

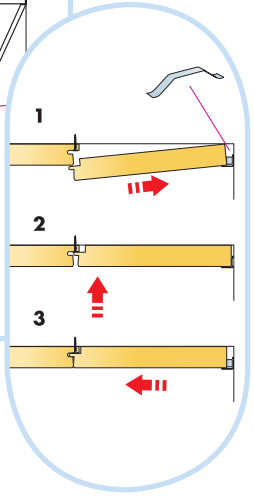
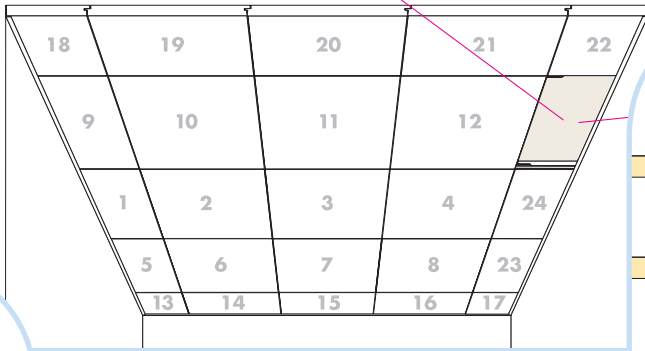
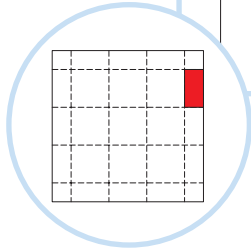

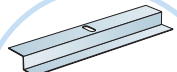
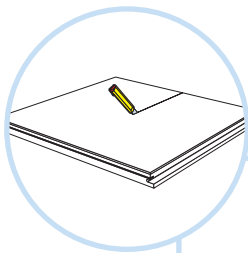

Connect Direct
fixing plate F



Connect
Installation
screw F

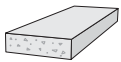
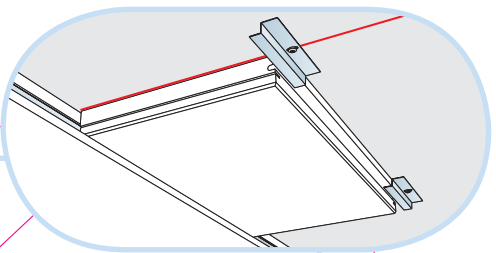

13

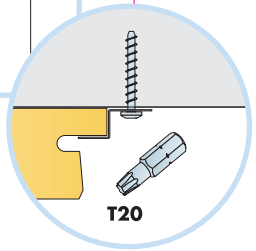
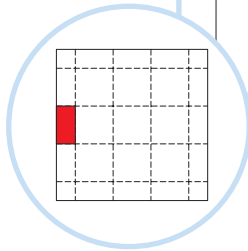
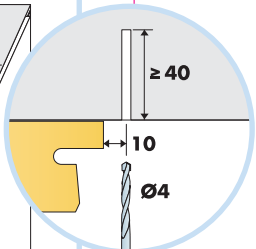
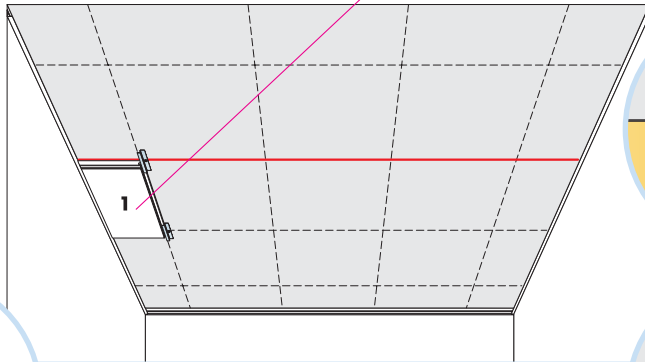

T20

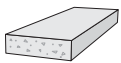
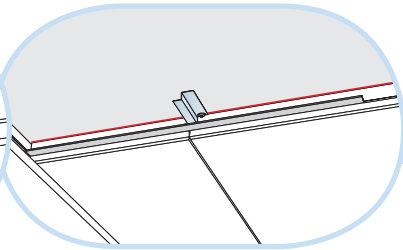
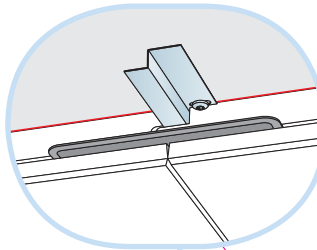

14

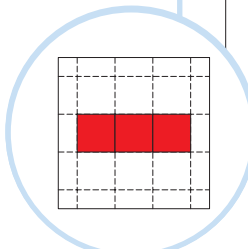
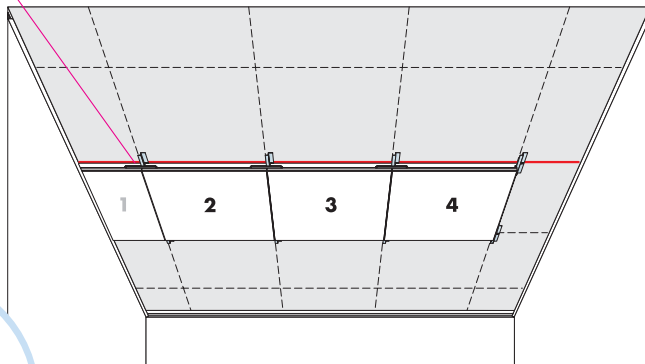

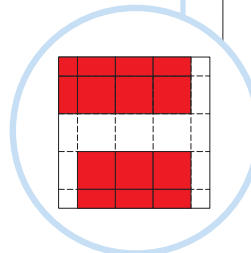
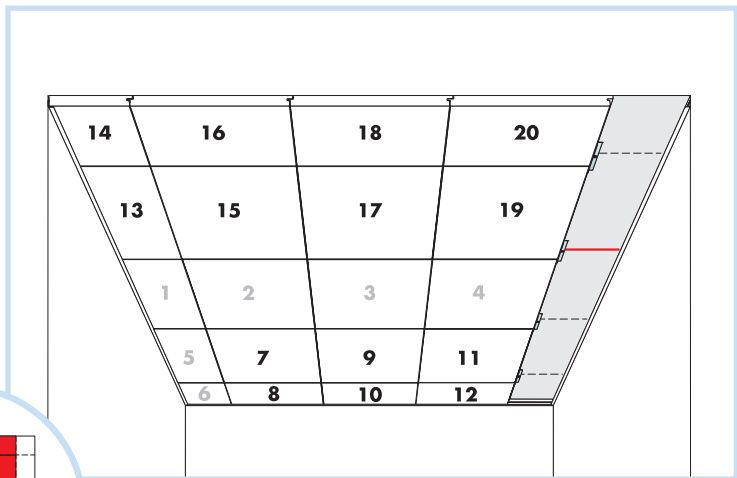
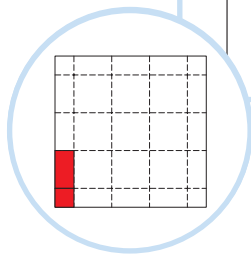
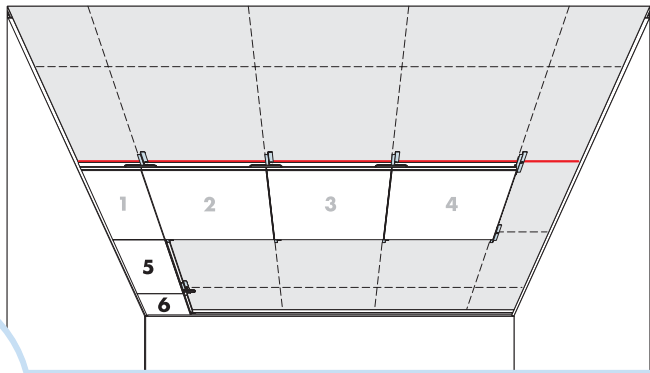
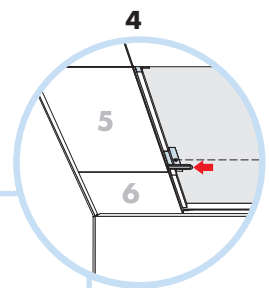
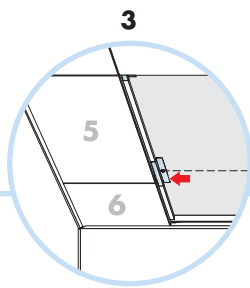
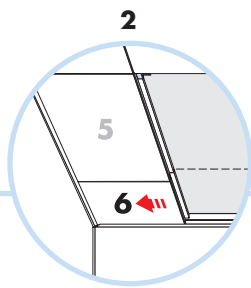
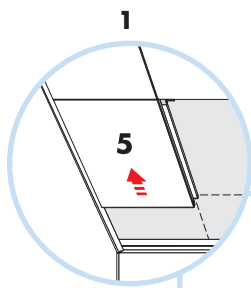

17

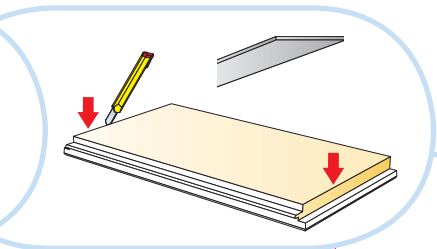
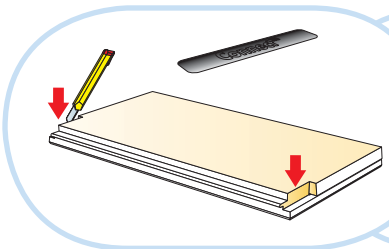
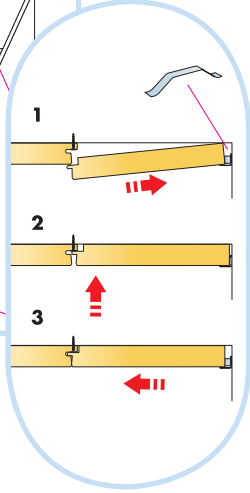
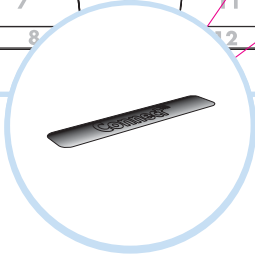
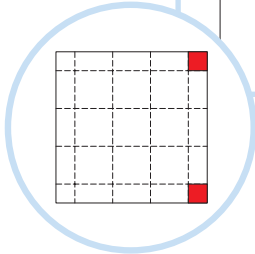
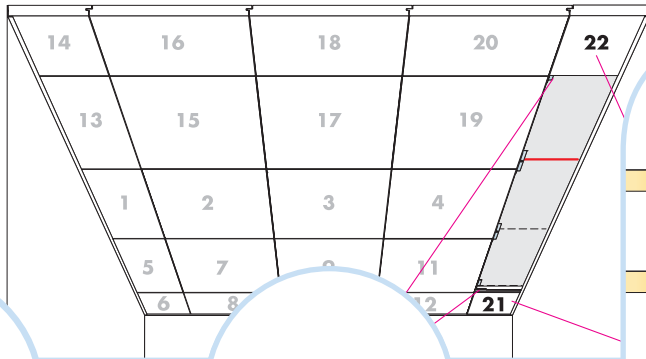
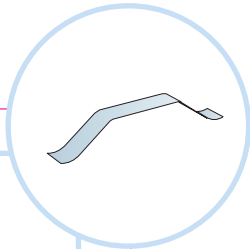
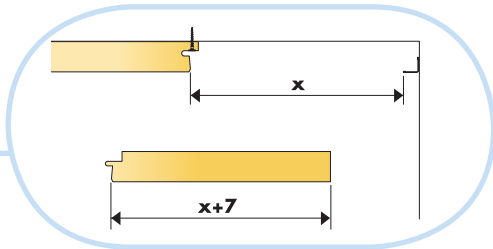
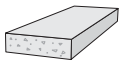

18

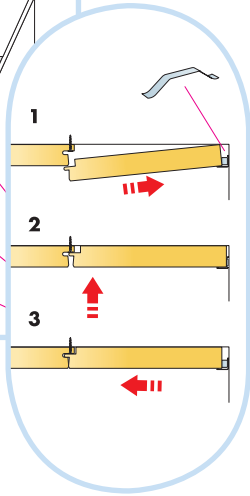
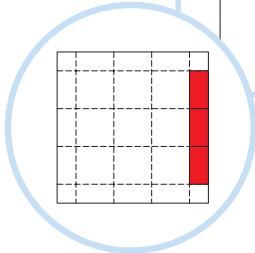
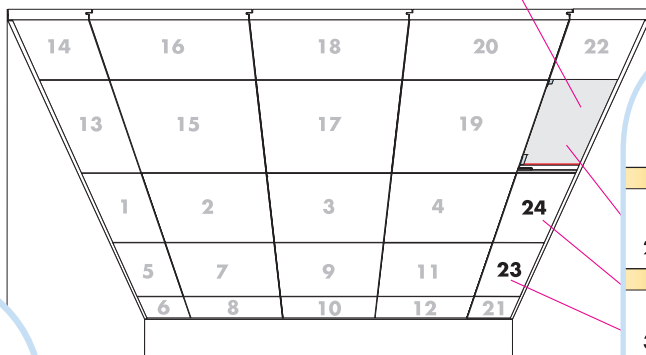
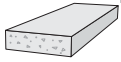

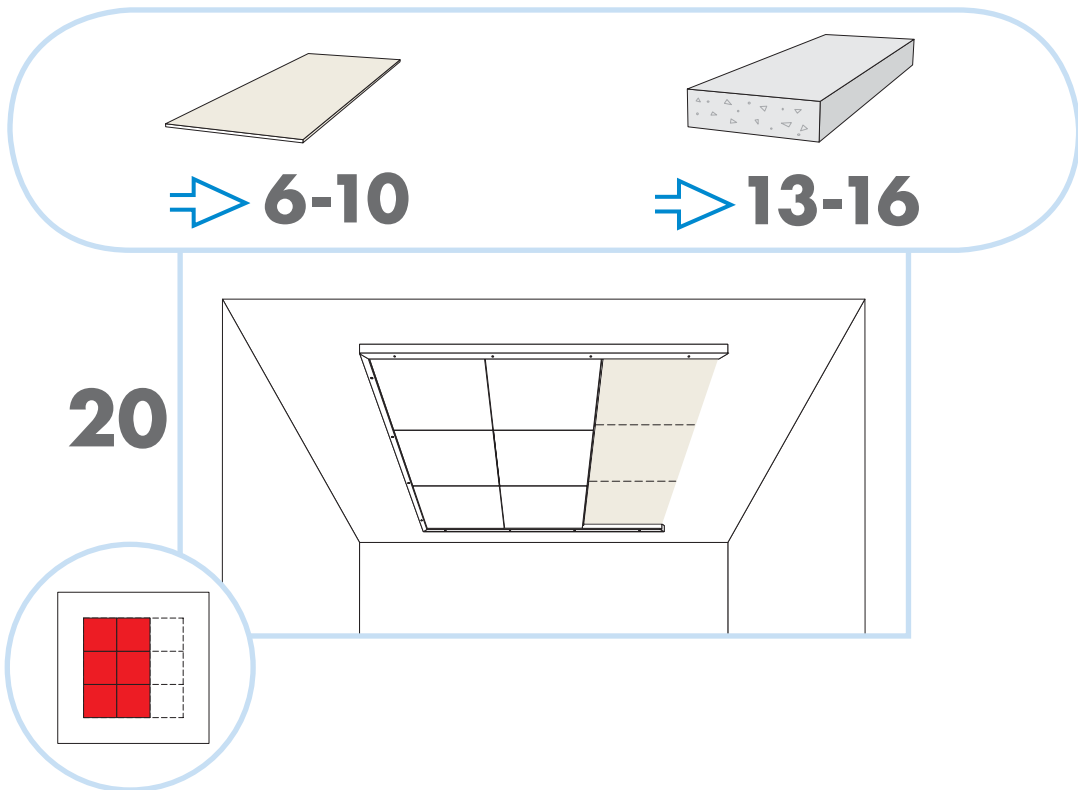
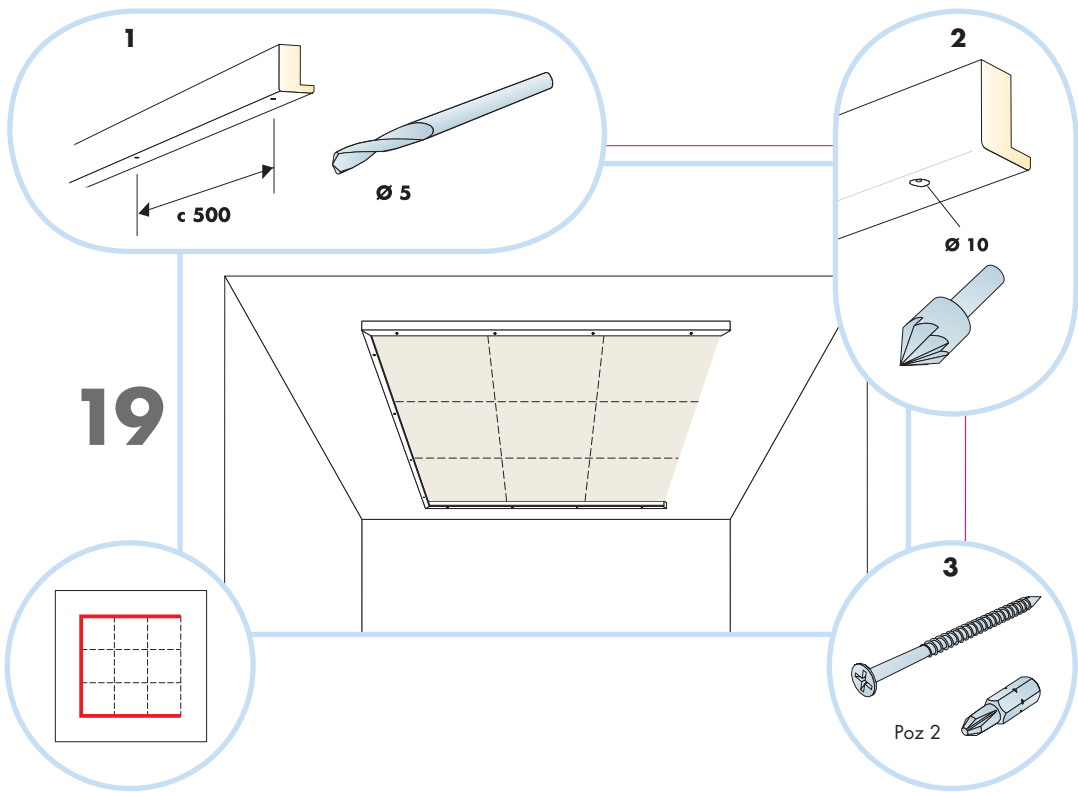

21

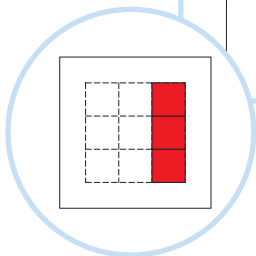
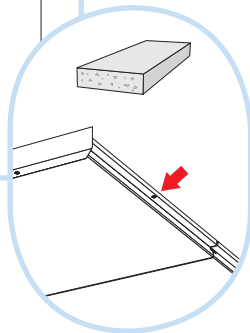
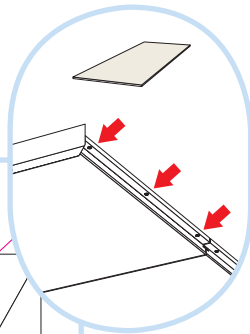
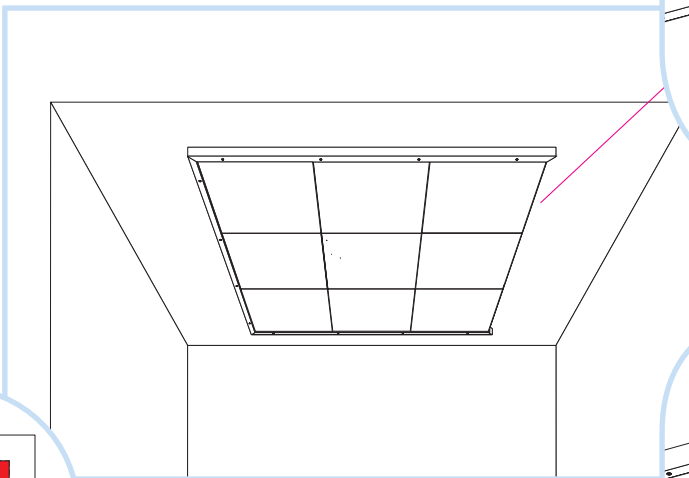

22

